

Homologowane czujniki dodatkowe

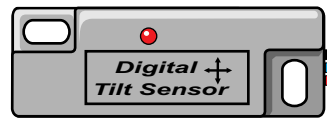

Żółto/zielony 5A  
zasilanie syrenki

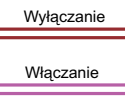
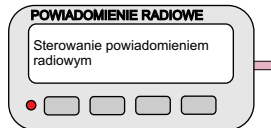
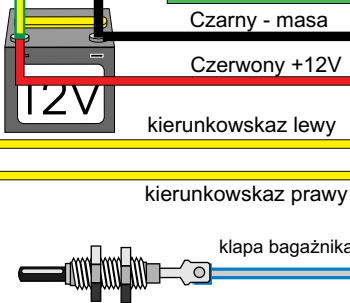
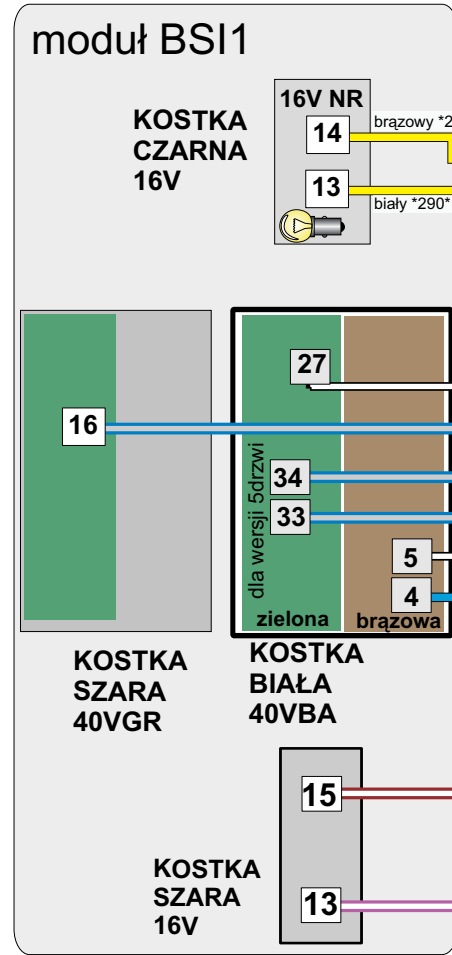

BLOKADA

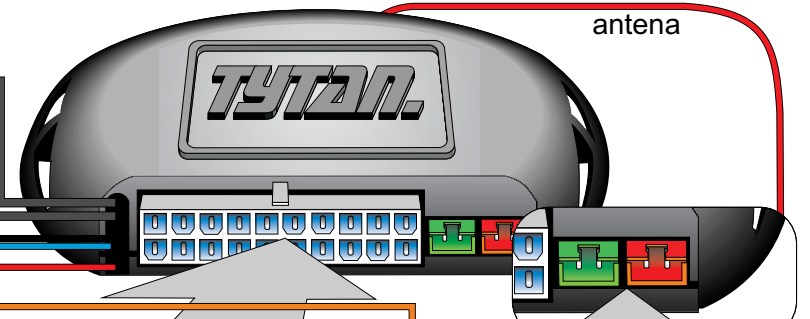
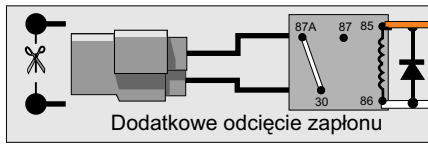

antena

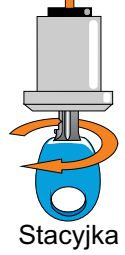
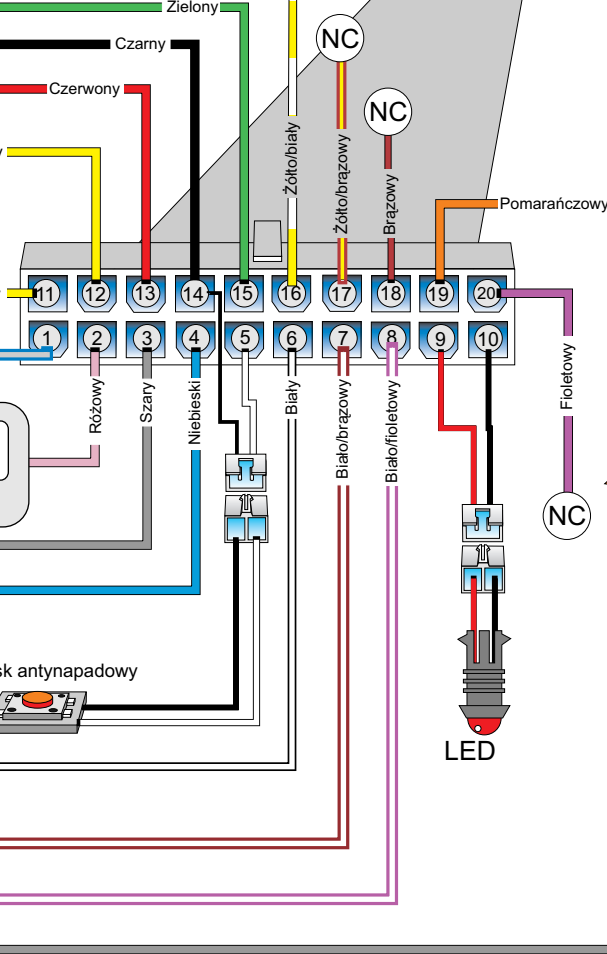

fabryczny przełącznik centralnego zamka

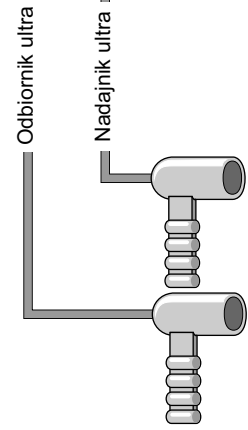

|   |                        |                                |                             |                     |
|---|------------------------|--------------------------------|-----------------------------|---------------------|
| Digital Systems sj<br>Krzysztof Baluta & Jacek Szmelczyński<br>84-230 Rumia, ul. Sędzickiego 57<br>tel./fax (58) 671-43-48, 671-01-14 | <b>TYTAN Ds300 RS</b>  | <b>Marka: CITROEN, PEUGEOT</b> | <b>Model: C8</b>            | <b>Rok: 03 &gt;</b> |
|   | Nr rys. 45h<br>Rev. 00 | <b>Parametr: 1 Poziom: 3</b>   | <b>Model: XSARA PICASSO</b> | <b>Rok: 03 &gt;</b> |
|   |                        |                                |                             | <b>Model: 807</b>   |