

Homologowane czujniki dodatkowe

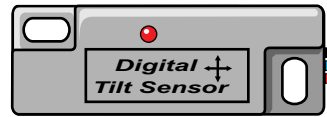

Żółto/zielony 5A  
zasilanie syrenki

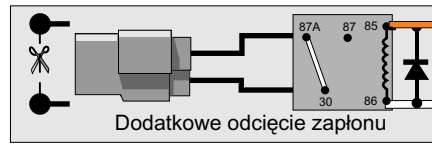
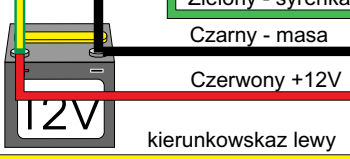
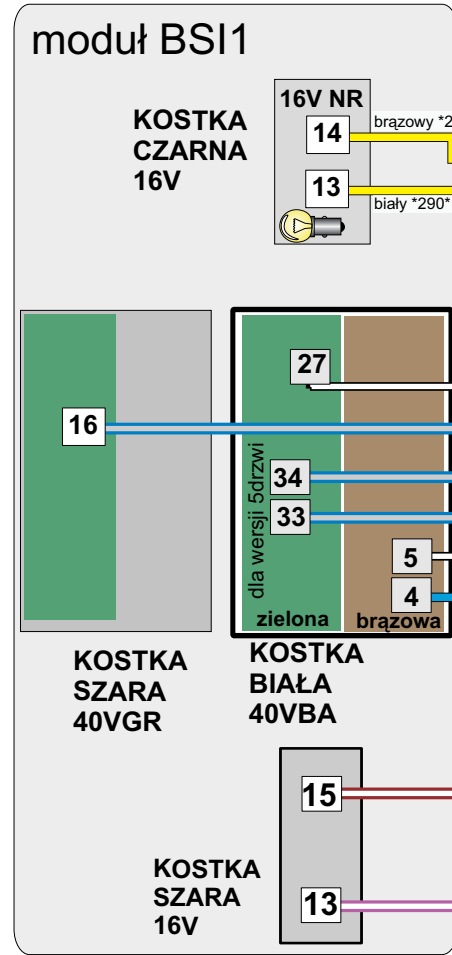

BLOKADA

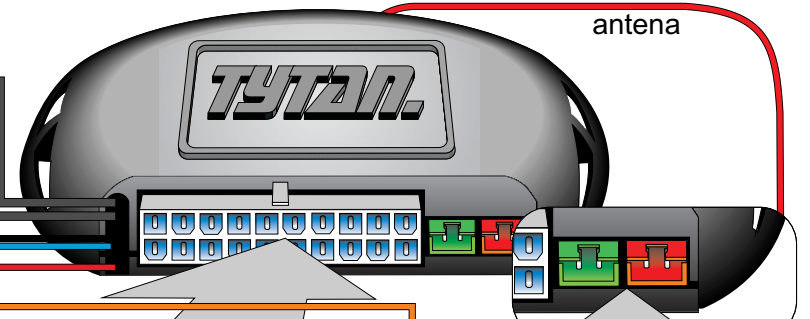

antena

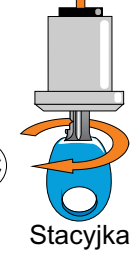
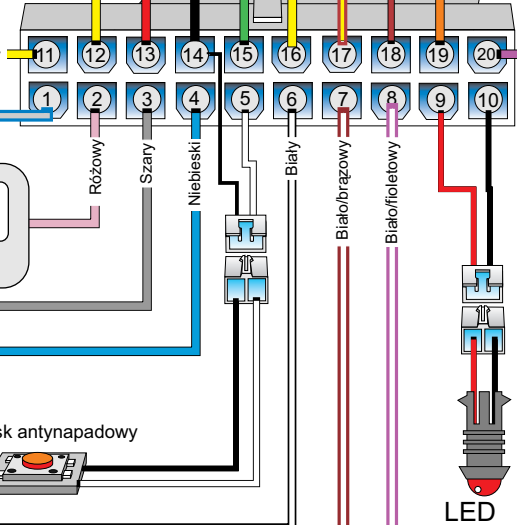
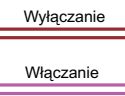
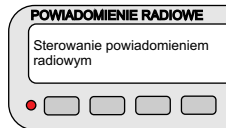

fabryczny przełącznik centralnego zamka

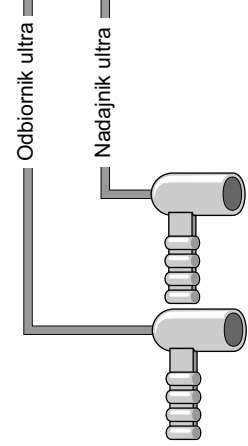
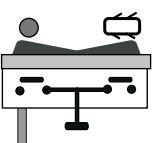

<p>Digital Systems sj Krzysztof Baluta &amp; Jacek Szmelczyński 84-230 Rumia, ul. Sędzickiego 57 tel./fax (58) 671-43-48, 671-01-14</p>	<p><b>TYTAN Ds300 RS</b></p>	<p><b>Marka: CITROEN, PEUGEOT</b></p>	<p><b>Model: C8</b></p>	<p><b>Rok: 03 &gt;</b></p>
	<p>Nr rys. 45h Rev. 00</p>	<p><b>Parametr: 1 Poziom: 3</b></p>	<p><b>Model: XSARA PICASSO</b></p>	<p><b>Rok: 03 &gt;</b></p>
			<p><b>Model: 807</b></p>	<p><b>Rok: 03 &gt;</b></p>