

Homologowane czujniki dodatkowe

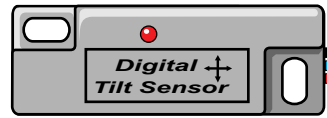

Żółto/zielony 5A
zasilanie syrenki

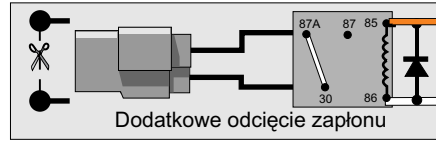

Zielony - syrenka
Czarny - masa
Czerwony +12V
15A

BLOKADA

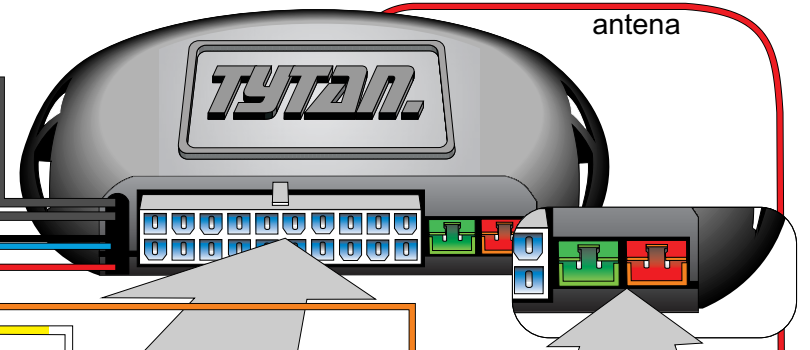

antena

Uwaga !!!
Zmienić poziom
z 1 na 2
w 5 parametrze

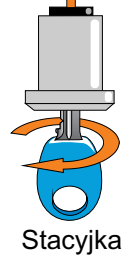
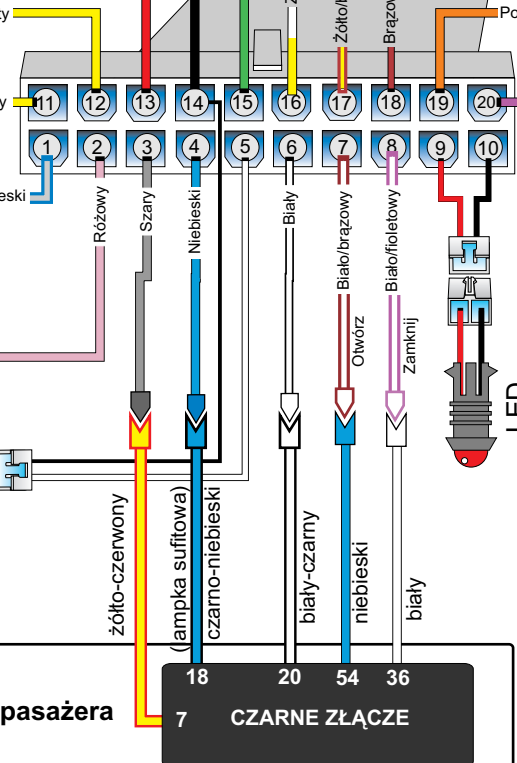
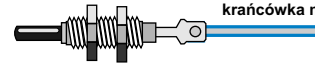
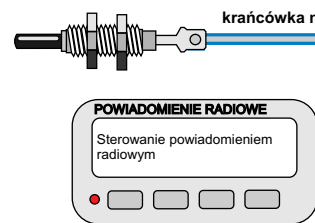
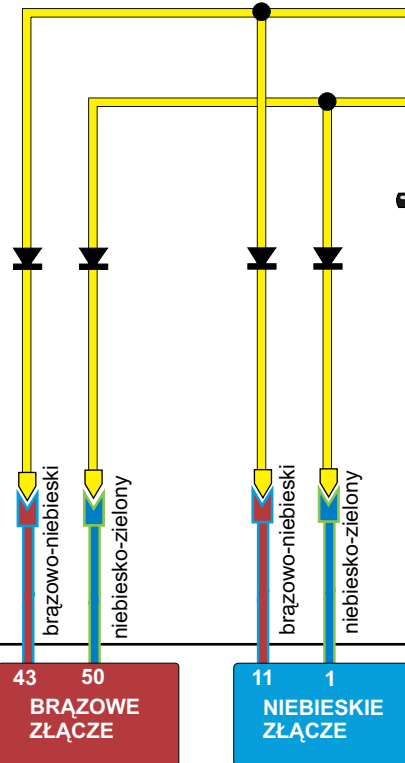

LCM zielono-niebieski 15 pin
wtyczka niebieska

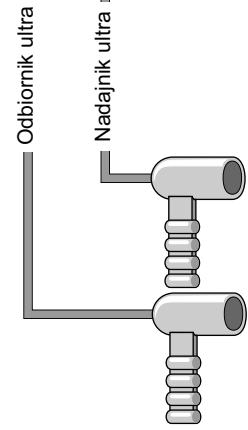

43 50
BRAZOWE ZŁĄCZE

11 1
NIEBIESKIE ZŁĄCZE

Moduł za schowkiem po stronie pasażera

18 20 54 36
7
CZARNE ZŁĄCZE

Digital Systems sj
Krzysztof Baluta & Jacek Szmelczyński
84-230 Rumia, ul. Sędzickiego 57
tel./fax (58) 671-43-48, 671-01-14

TYTAN Ds300 RS
Nr rys. 4h
Rev. 00

Marka: BMW
Parametr: 1 Poziom: 5

Model: 3

Rok: 98 - 03